







 $\varnothing 6,3 \times 50 \text{ mm}$ <b>A1 x 10</b>	 $\varnothing 12 \text{ mm}$ <b>A2 x 10</b>	 4 mm <b>A3 x 1</b>	 $\varnothing 15 \times 12 \text{ mm}$ <b>B1 x 3</b>	 $\varnothing 5 \times 44 \text{ mm}$ <b>B2 x 3</b>
 $\varnothing 20 \text{ mm}$ <b>B3 x 3</b>	 $\varnothing 4 \times 16 \text{ mm}$ <b>D x 8</b>	 $\varnothing 8 \times 36 \text{ mm}$ <b>G x 8</b>	 h 7 mm <b>N x 4</b>	



# Box 1/1

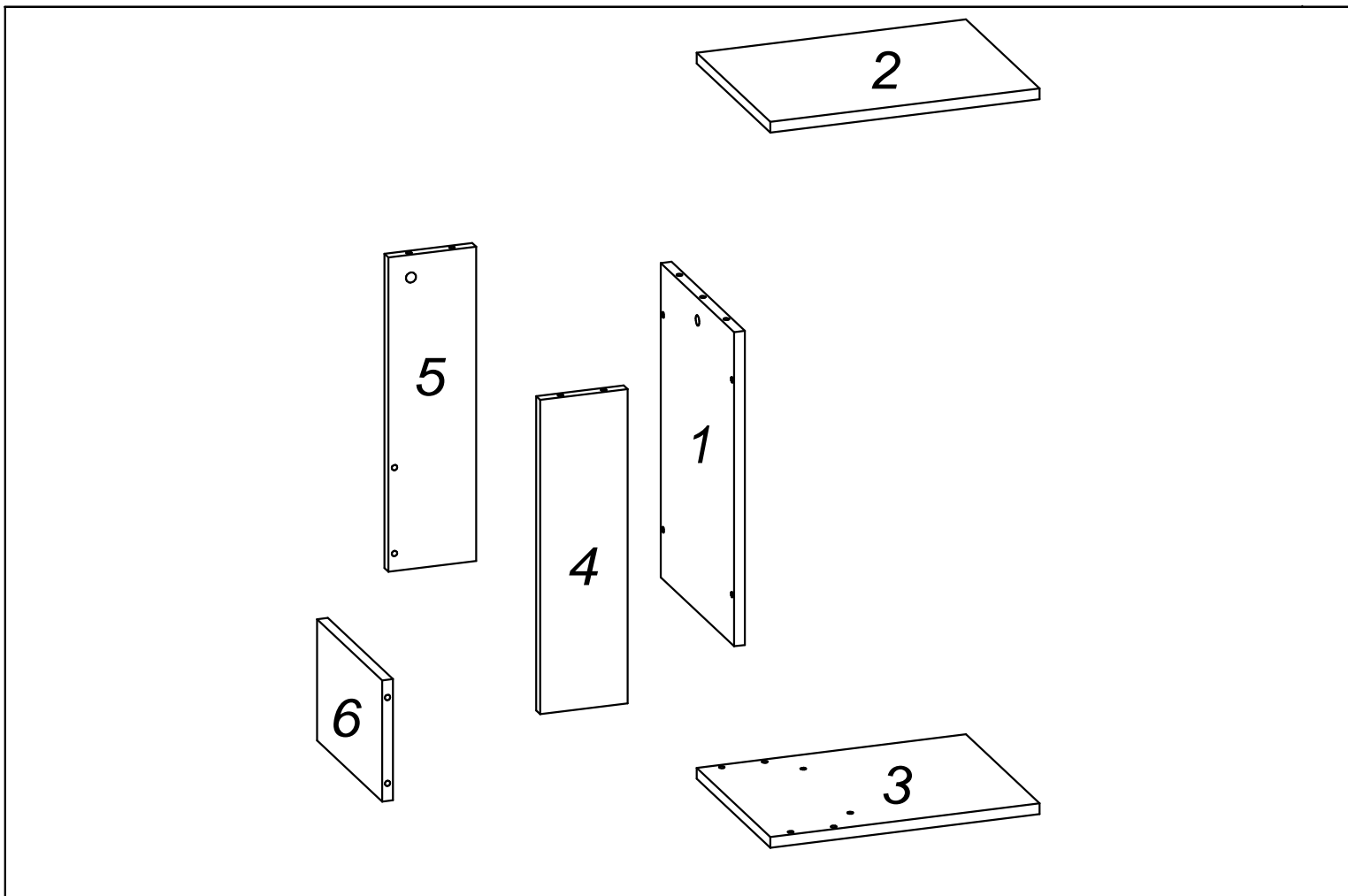
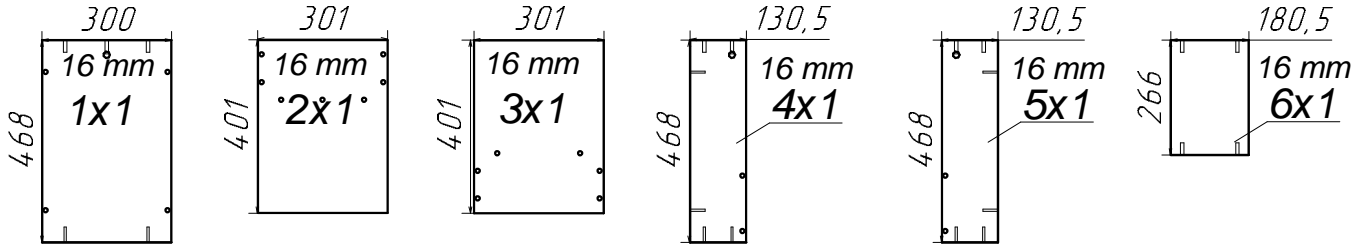

Fittings & Tools

--	--	--	--

1

 <p>Ø15x12 mm B1 x 1</p>	 <p>Ø5x44 mm B2 x 3</p>	 <p>Ø8x36 mm G x 4</p>						
---	--	---	--	--	--	--	--	--

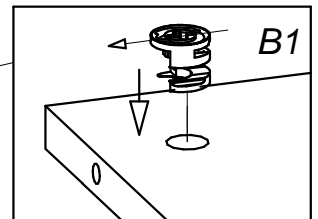
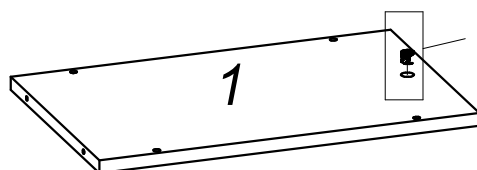
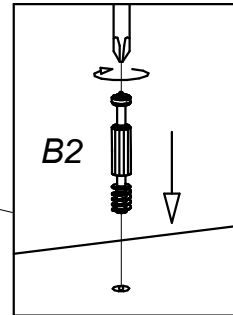
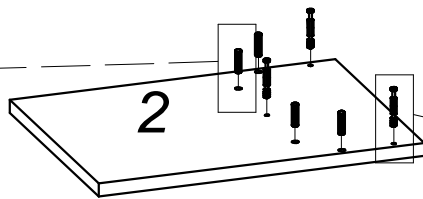
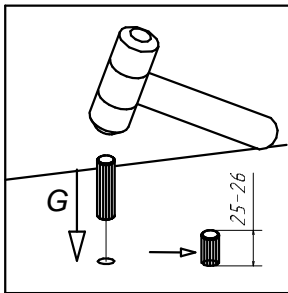

2

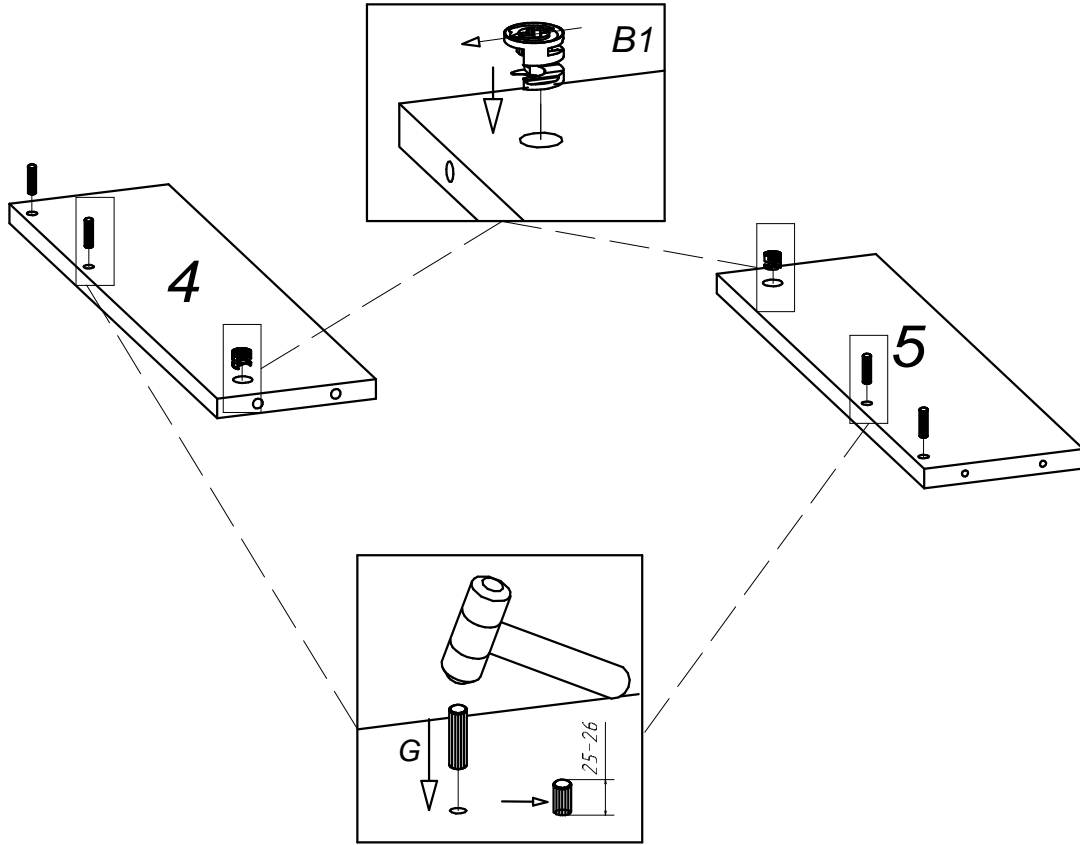

3

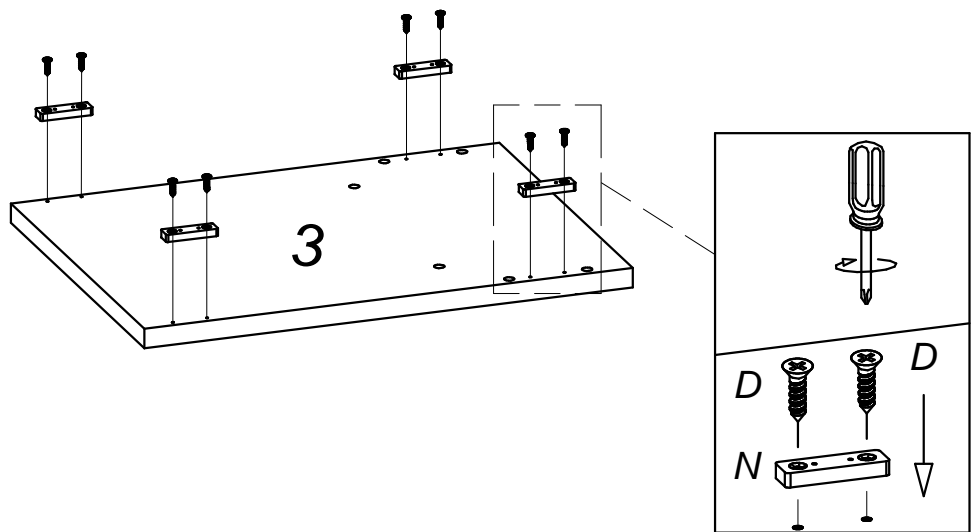

4

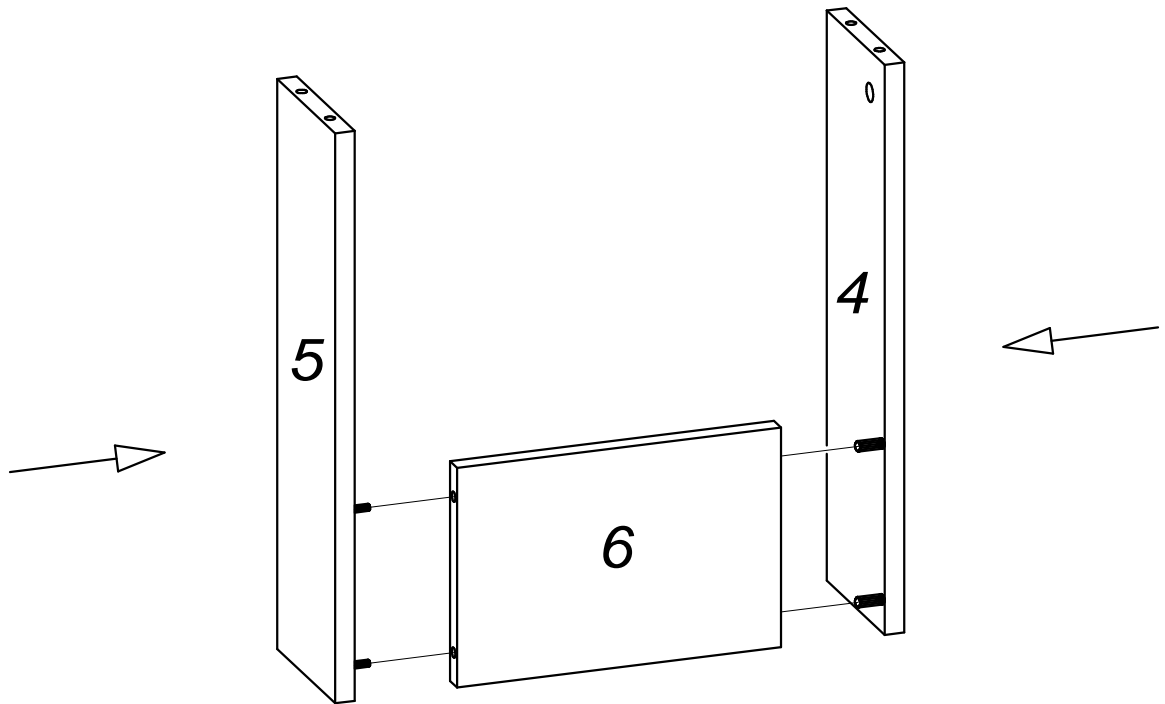
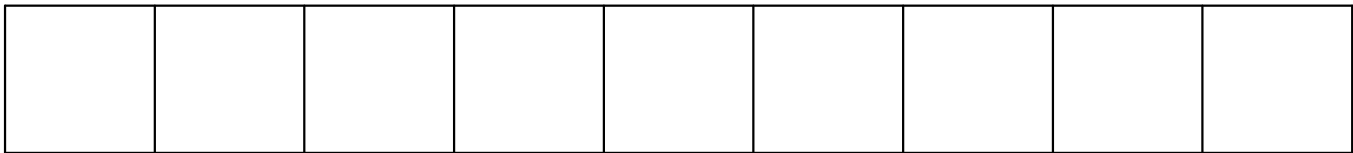

5

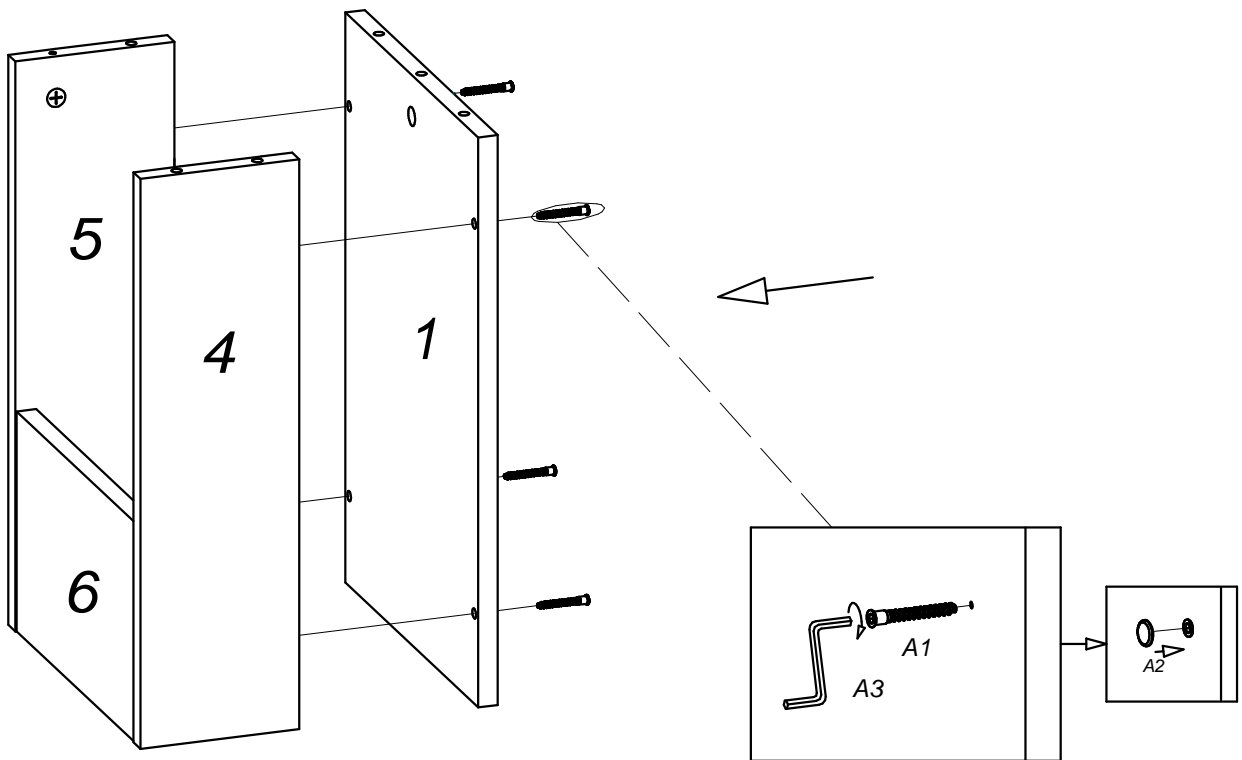
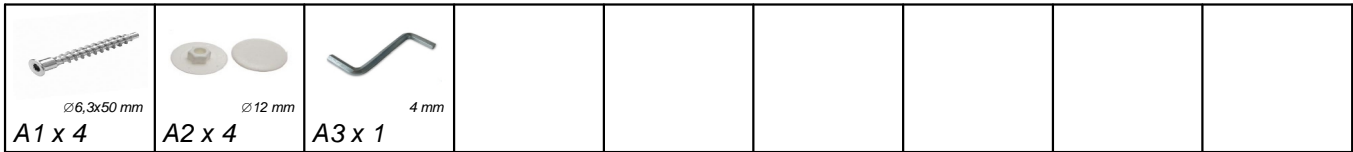

6

 A1 x 6 Ø6,3x50 mm	 A2 x 6 Ø12 mm	 A3 x 1 4 mm	 B3 x 3 Ø20 mm					
--	--	--	--	--	--	--	--	--

